

1665050000-JEXM/A 100

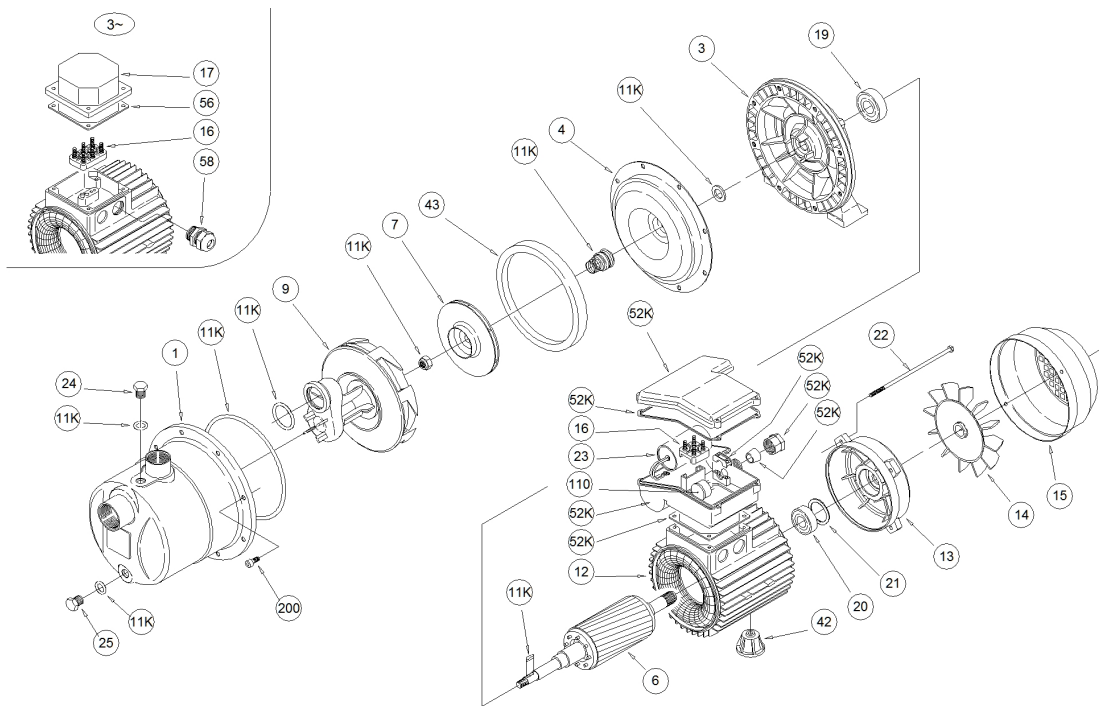

1665050000-JEXM/A 100

Position	Code	Description	Note	Qty
1	251420682	CASING		1
3	240280545	MOTOR BRAKET		1
4	251438005	CASING COVER		1
7	251450700	IMPELLER		1
9	342535022	DIFFUSER		1
11K	364500014	MECHANICAL SEAL KIT		1
13	230225501	MOTOR COVER		1
15	362250002	FAN COVER		1
21	360600035	SPACER RING		1
22	369305135	TIE ROD		4
24	375192002	PLUG		1
25	375192002	PLUG		1
42	371415013	FOOT		1
43	342535010	SPACER		1
56	364700810	GASKET		1
200	369600023	SCREW		8
19	360306210	BEARING		1
20	360306211	BEARING		1
14	369950017	FAN		1
16	365940253	TERMINAL BOARD		1
52K	352665057	TERMINAL BOX KIT		1
23	361410020	CAPACITOR		1
6	275412084	SHAFT		1
12	277930174	MOTOR		1