

2541080000-3D 40-125/1,5 M

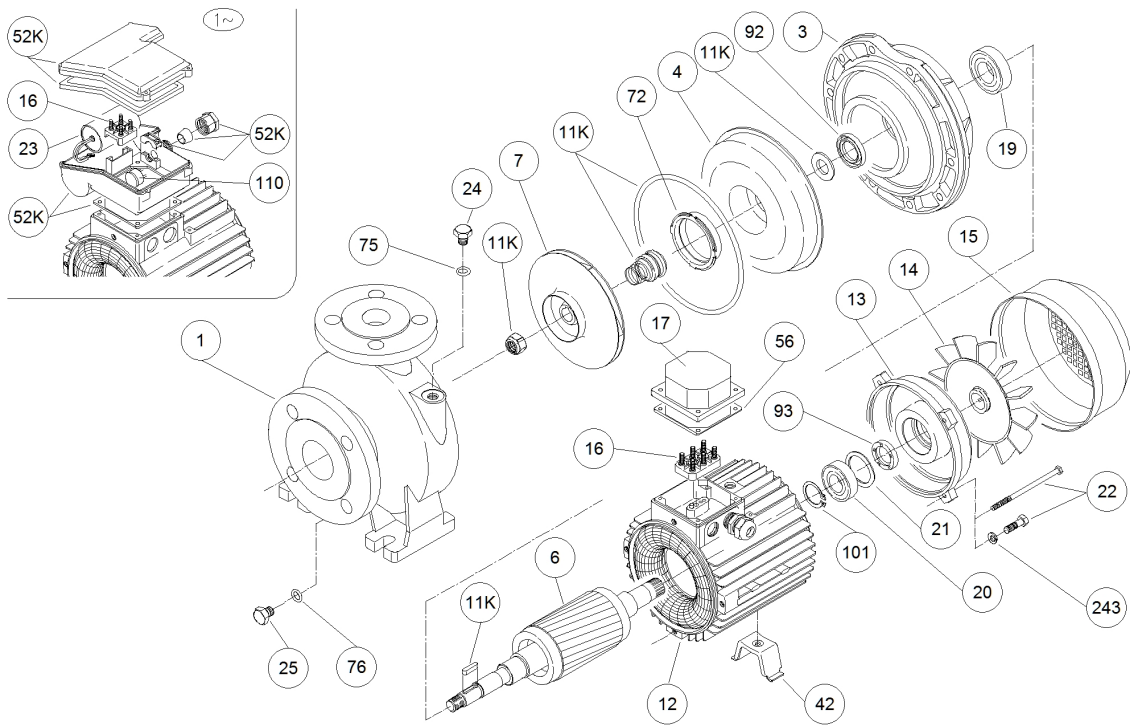

2541080000-3D 40-125/1,5 M

Position	Code	Description	Note	Qty
1	245021073	BOTTOM CASING		1
3	240080367	MOTOR BRACKET		1
4	251438000	CASING COVER		1
7	251450644	IMPELLER		1
15	362250009	FAN COVER		1
21	360600052	ADJUSTING RING		1
24	375192500	PLUG		1
25	375192500	PLUG		1
42	371415011	FOOT		1
56	364700811	GASKET		1
75	360620003	WASHER		1
76	360620003	WASHER		1
92	360991531	LIP SEAL		1
93	360991531	LIP SEAL		1
13	230225504	MOTOR COVER		1
12	257930281	MOTOR FRAME		1
6	275412282	SHAFT		1
52K	352665059	TERMINAL BOX KIT		1
19	360316205	BEARING		1
20	360316205	BEARING		1
23	361410040	CAPACITOR		1
58	363201201			1
11K	364500000	MECHANICAL SEAL KIT		1
16	365940254	TERMINAL BOARD		1
22	369305165	TIE ROD		4
110	369450517	PROTECTOR		1
14	369950009	FAN		1