

2542100000-3D 50-125/2,2 M

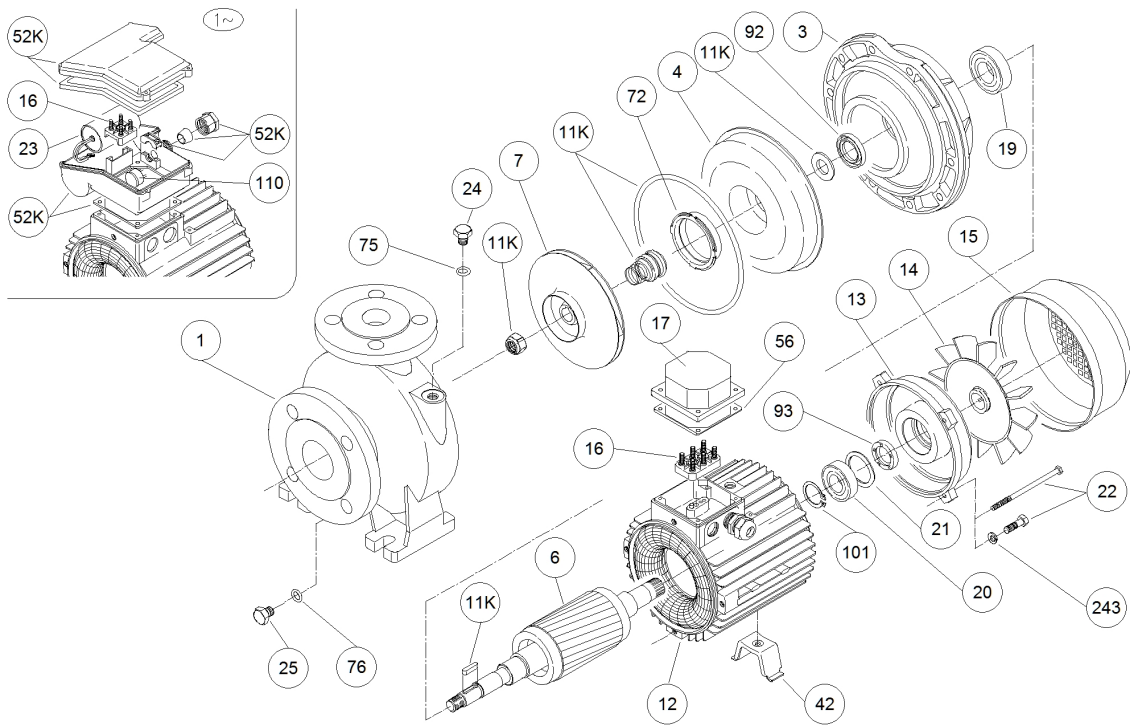

2542100000-3D 50-125/2,2 M

Position	Code	Description	Note	Qty
1	245021076	BOTTOM CASING		1
3	240080365	MOTOR BRACKET		1
4	251438001	CASING COVER		1
7	251450653	IMPELLER		1
15	362250009	FAN COVER		1
21	360600052	ADJUSTING RING		1
24	375192500	PLUG		1
25	375192500	PLUG		1
42	371415000	FOOT		1
56	364700811	GASKET		1
75	360620003	WASHER		1
76	360620003	WASHER		1
92	360991531	LIP SEAL		1
93	360991531	LIP SEAL		1
13	230225504	MOTOR COVER		1
6	275412258	SHAFT		1
12	277930257	MOTOR FRAME		1
52K	352665059	TERMINAL BOX KIT		1
19	360316205	BEARING		1
20	360316205	BEARING		1
23	361410050	CAPACITOR		1
58	363201201			1
11K	364500000	MECHANICAL SEAL KIT		1
16	365940254	TERMINAL BOARD		1
22	369305165	TIE ROD		4
110	369450603	PROTECTOR		1
14	369950009	FAN		1