

26551000145-3445100014-EVMS10 14N5 Q1BEG E/5,5 ETM

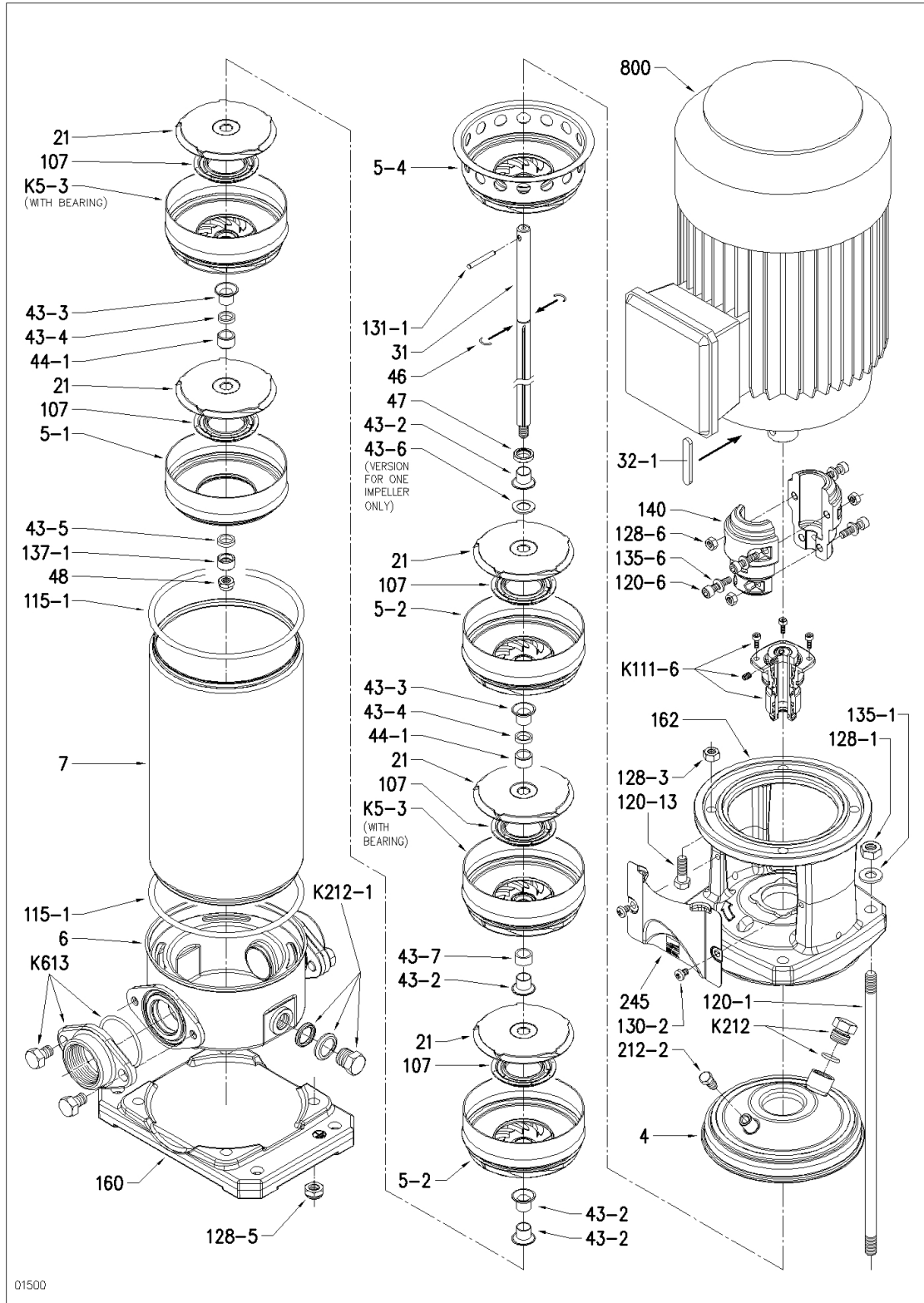

26551000145-3445100014-EVMS10 14N5 Q1BEG E/5,5 ETM

Position	Code	Description	Qty
5-2	254482183	INTERMEDIATE CASING	1
128-1	740040002	NUT	4
5-4	251482182	DISCHARGE CASING	1
128-5	740040005	NUT	4
4	251438062	CASING COVER + VENTING PLUG	1
6	251421130	BOTTOM CASING	1
46	360970016	HALF-COUPLING	2
47	241310267	RING	1
48	363300121	NUT	1
160	240072272	BASE	1
115-1	360921645	O-RING	2
130-2	369640002	BOLT	4
131-1	367936793	PIN	1
137-1	371434096	IMPELLER SPACER	1
212-2	375340070	VENTING PLUG	1
5-1	254482081	SUCTION CASING+RASAMENTO	1
K111-6	371416192	KIT CARTRIDGE+MECH.SEAL+O-RING	1
K212	369270007	KIT PLUG+O-RING	1
K212-1	369270006	KIT PLUG+WASHER+O-RING	2
K613	364400063	KIT FLANGE	1
140	275449224	HALF-COUPLING	2
162	240080725	MOTOR BRACKET	1
245	271473226	COUPLINGUARD	2
120-13	369600053	BOLT	4
120-6	369641008	BOLT	4
128-3	363300162	NUT	4
32-1	361336216	KEY	1
43-3	371416173	SPACER	2
44-1	371416186	BEARING	2
K5-3	253402792	KIT INTERMEDIATE CASING + BEARING+LINER RING	2
7	285427424	OUTER CASING	1
21	251450433	IMPELLER	14
31	275411058	SHAFT	1
107	251410276	LINER RING	14
43-2	371416173	SPACER	2