

26351000115-3425100011-EVMS3 11N5 Q1BEG E/1,1 ETM

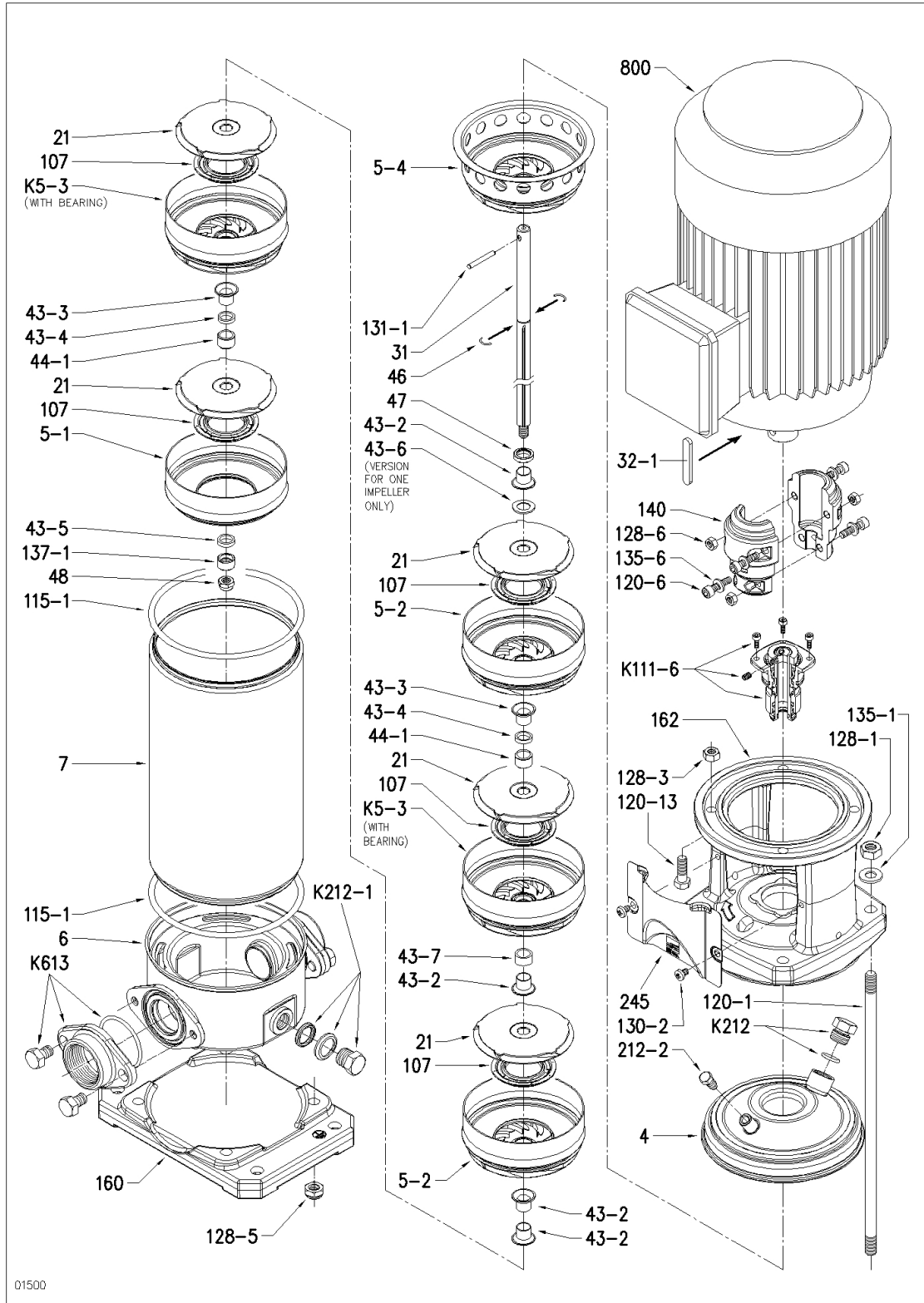

26351000115-3425100011-EVMS3 11N5 Q1BEG E/1,1 ETM

Position	Code	Description	Qty
4	251438060	CASING COVER + VENTING PLUG	1
6	251421129	BOTTOM CASING	1
46	360970012	HALF-RING	2
47	241310268	RING	1
48	363300120	NUT	1
160	240072270	BASE	1
245	271473220	COUPLINGUARD	2
115-1	360921295	O-RING	2
120-13	369600048	BOLT	4
120-6	369641004	BOLT	4
128-5	363300011	NUT	4
128-6	363304001	NUT	4
130-2	369640002	BOLT	4
131-1	367936792	PIN	1
135-6	360610030	WASHER	4
137-1	371434095	IMPELLER SPACER	1
212-2	375340070	VENTING PLUG	1
43-3	371416170	SPACER	19
44-1	371416185	BEARING	1
5-1	254482076	SUCTION CASING+RASAMENTO	1
5-4	251482077	DISCHARGE CASING	1
K111-6	371416190	KIT CARTRIDGE+MECH.SEAL+O-RING	1
K212	369270007	KIT PLUG+O-RING	1
K212-1	369270006	KIT PLUG+WASHER+O-RING	2
K5-3	253402794	KIT INTERMEDIATE CASING + BEARING+LINER RING	1
K613	364400060	KIT FLANGE	1
140	275449202	HALF-COUPLING	2
162	240080707	MOTOR BRACKET	1
32-1	361336211	KEY	1
7	285427364	OUTER CASING	1
21	251450429	IMPELLER	11
31	275411013	SHAFT	1
107	251410273	LINER RING	11
43-2	371416170	SPACER	19
5-2	254482075	INTERMEDIATE CASING+LINER RING	9