

2655000055-344500005-EVMSG10 5N5 Q1BEG E/2,2 ETM

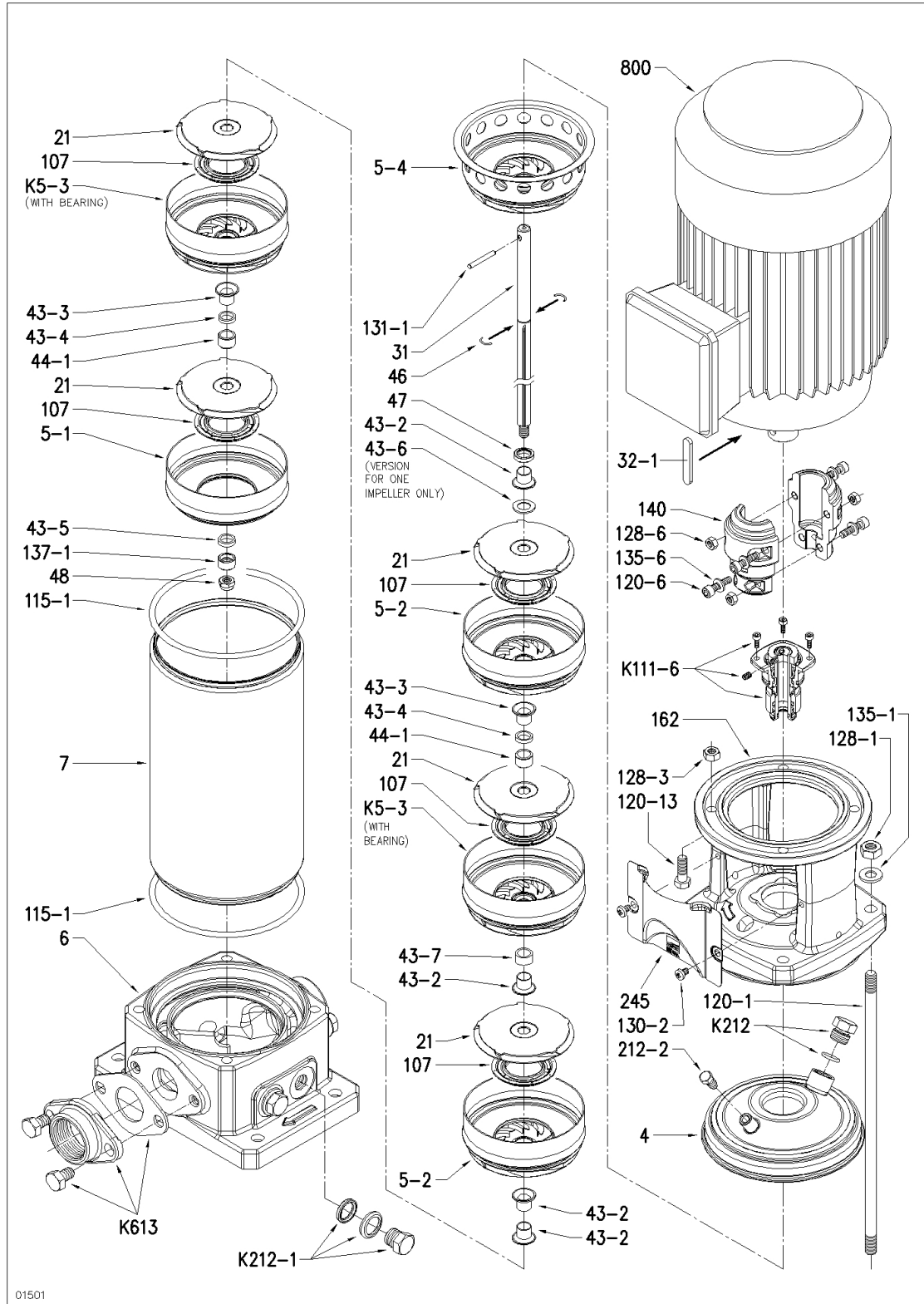

2655000055-344500005-EVMSG10 5N5 Q1BEG E/2,2 ETM

Position	Code	Description	Qty
5-2	254482183	INTERMEDIATE CASING	1
93	360991523	LIP SEAL	1
128-1	740040002	NUT	4
5-4	251482182	DISCHARGE CASING	1
4	251438062	CASING COVER + VENTING PLUG	1
6	240021140	BOTTOM CASING	1
46	360970016	HALF-COUPLING	2
47	241310267	RING	1
48	363300121	NUT	1
245	271473224	COUPLINGUARD	2
115-1	360921645	O-RING	2
120-6	369641004	BOLT	4
128-6	363304001	NUT	4
130-2	369640002	BOLT	4
131-1	367936793	PIN	1
135-6	360610030	WASHER	4
137-1	371434096	IMPELLER SPACER	1
212-2	375340070	VENTING PLUG	1
43-3	371416173	SPACER	7
44-1	371416186	BEARING	1
5-1	254482081	SUCTION CASING+RASAMENTO	1
K111-6	371416192	KIT CARTRIDGE+MECH.SEAL+O-RING	1
K212	369270007	KIT PLUG+O-RING	1
K212-1	369270006	KIT PLUG+WASHER+O-RING	4
K5-3	253402792	KIT INTERMEDIATE CASING + BEARING+LINER RING	1
K613	364400077	KIT FLANGE	1
140	275449192	HALF-COUPLING	2
162	240080721	MOTOR BRACKET	1
32-1	361336212	KEY	1
120-13	369600037	BOLT	4
7	285427416	OUTER CASING	1
21	251450433	IMPELLER	5
31	275411050	SHAFT	1
107	251410276	LINER RING	5
43-2	371416173	SPACER	7