

26350100195-3425010019-EVMSG3 19F5 Q1BEG E/2,2 ETM

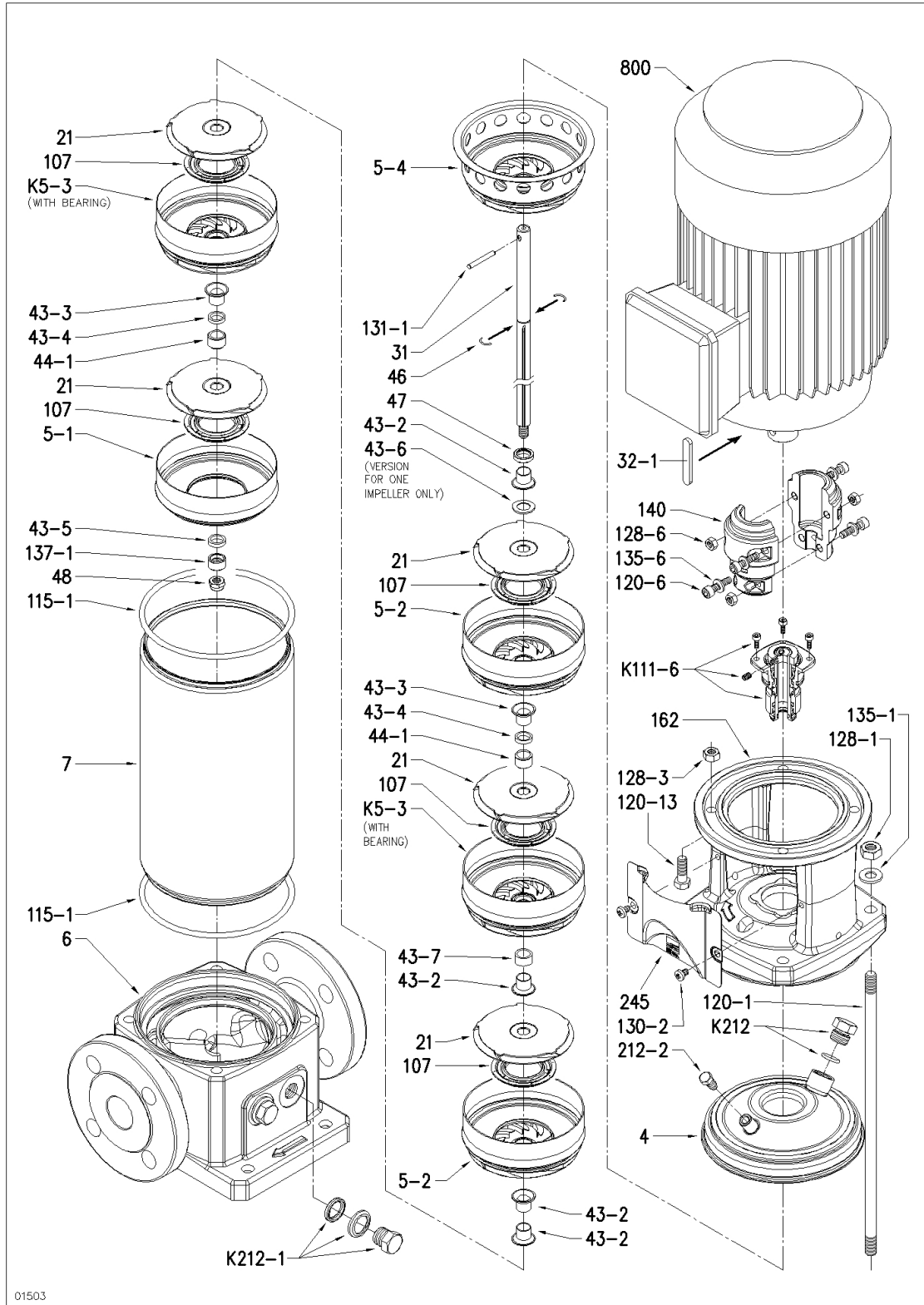

26350100195-3425010019-EVMSG3 19F5 Q1BEG E/2,2 ETM

Position	Code	Description	Qty
4	251438060	CASING COVER + VENTING PLUG	1
6	240021130	BOTTOM CASING	1
46	360970012	HALF-RING	2
47	241310268	RING	1
48	363300120	NUT	1
115-1	360921295	O-RING	2
120-6	369641004	BOLT	4
128-6	363304001	NUT	4
130-2	369640002	BOLT	4
131-1	367936792	PIN	1
135-6	360610030	WASHER	4
137-1	371434095	IMPELLER SPACER	1
212-2	375340070	VENTING PLUG	1
5-1	254482076	SUCTION CASING+RASAMENTO	1
5-4	251482077	DISCHARGE CASING	1
K111-6	371416190	KIT CARTRIDGE+MECH.SEAL+O-RING	1
K212	369270007	KIT PLUG+O-RING	1
K212-1	369270006	KIT PLUG+WASHER+O-RING	4
140	275449204	HALF-COUPLING	2
162	240080709	MOTOR BRACKET	1
245	271473221	COUPLINGUARD	2
120-13	369600037	BOLT	4
32-1	361336212	KEY	1
43-3	371416170	SPACER	33
43-7	371416221	SPACER	1
44-1	371416185	BEARING	2
K5-3	253402794	KIT INTERMEDIATE CASING + BEARING+LINER RING	2
7	285427375	OUTER CASING	1
21	251450429	IMPELLER	19
31	275411024	SHAFT	1
107	251410273	LINER RING	19
43-2	371416170	SPACER	33
5-2	254482075	INTERMEDIATE CASING+LINER RING	16