

1771031404-RIGHT 75 10 m

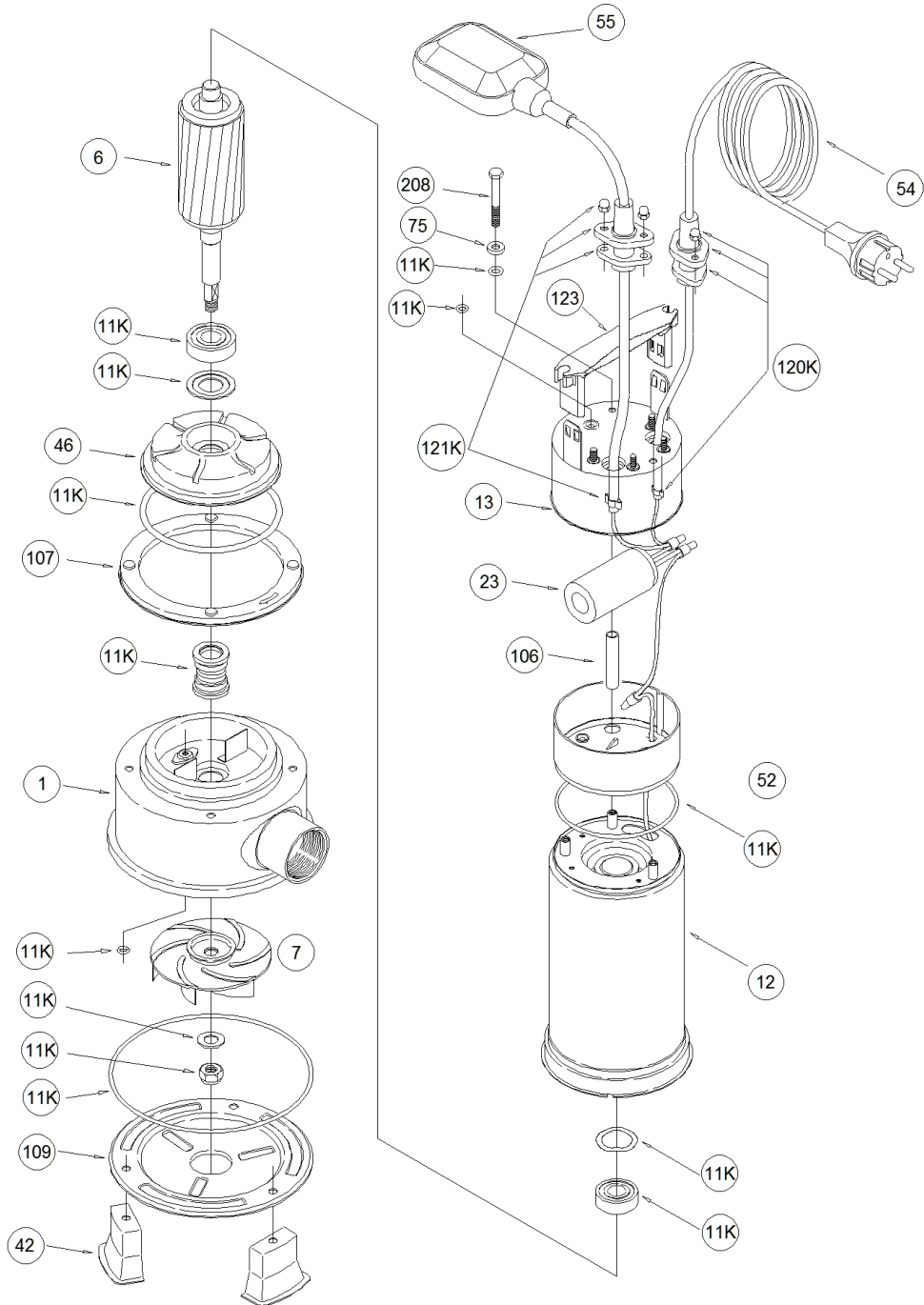

1771031404-RIGHT 75 10 m

Position	Code	Description	Qty
123	251460029	HANDLE	1
75	360676021	WASHER	3
1	251402130	CASING	1
106	375434024	SCREW SPACER	3
107	251402129	COUPLING RING	1
109	230225068	SUCTION SIDE COVER	1
11K	364500016	MECHANICAL SEAL KIT	1
12	257902025	MOTOR FRAME	1
13	251402190	MOTOR COVER	1
208	369605006	SCREW	3
42	371472032	FOOT	3
46	240480007	BEARING HOUSING	1
52	372582001	TERMINAL INSULATING BOX	1
54	367900028	CABLE	1
6	275412192	SHAFT	1
7	241450716	IMPELLER	1
75	360676020	WASHER	3
120K	352665022	KIT CABLE CONNECTOR	1
12	257902125	MOTOR FRAME	1
13	251402189	MOTOR COVER	1
23	361401200	CAPACITOR	1
54	367900008	CABLE	1
55	365231074	FLOAT SWITCH	1
6	275412194	SHAFT	1
120K	352665014	KIT CABLE CONNECTOR	1
121K	352665014	KIT CABLE CONNECTOR	1
13	251402196	MOTOR COVER	1
54	367931103	CABLE	1
55	365200070	FLOAT SWITCH	1
54	367900007	CABLE	1
54	367931061	CABLE	1
12	257902031	MOTOR FRAME	1
6	275412191	SHAFT	1
7	241450715	IMPELLER	1
12	257902131	MOTOR FRAME	1
23	361401315	CAPACITOR	1
6	275412193	SHAFT	1